

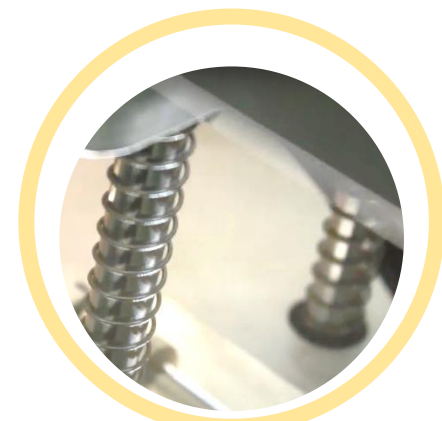

未來的 工作世界



選技職、好好讀、有前途



高職優質化工作小組

簡報 大綱

1

有前途

2

好好讀

3

選技職



1
有前途

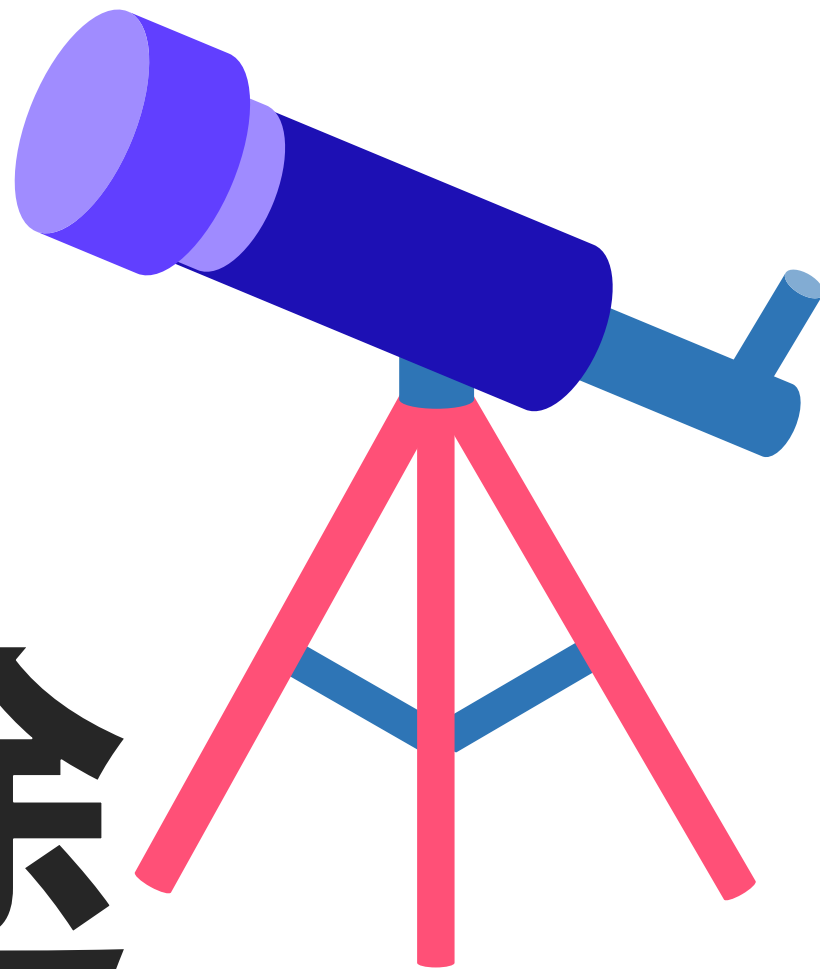



我的生活都離不開技職

日常生活周邊產品（服務）

製造、服務提供者（技術）



以智慧型手機為例



造型、機身結構設計、零組件製造



模具製造或精密機械加工

造型設計



工業類



工業類、
藝術與設計類

以智慧型手機為例

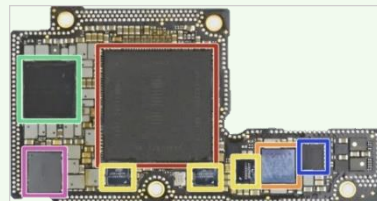

IC設計、電路系統設計與製造



IC設計、電子電路設計



工業類



電路板、零件加工



工業類

以智慧型手機為例



網頁設計、資料運用、APP應用程式

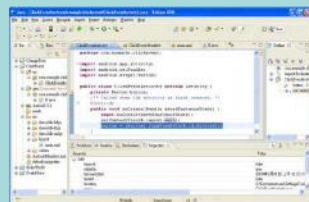

程式設計



工業類、商業類



網頁設計



商業類、
藝術與設計類

以超商飯糰 為例



以 超商飯糰 為例



稻米栽培
米食加工



農業類



鮭魚餡料



海事水產類、農業類



食品營養



農業類、家事類



食品加工



農業類

以 超商飯糰 為例



便利商店



商業經營
門市服務



商業類



物流管理



商業類



電子商務



商業類

好好讀

2





技術型高中 6類15群

工業類

商業類

家事類

海事水產類

農業類

藝術與設計類



工業類

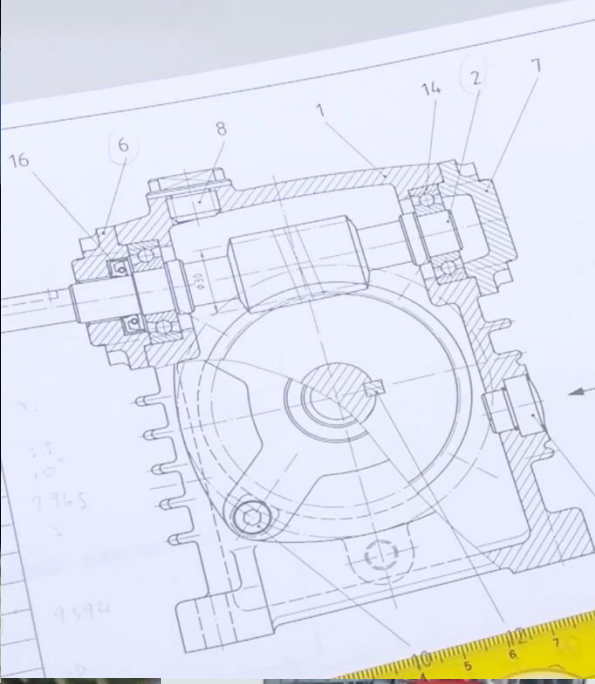

就業選擇

工程師、程式設計師、建築師、專業技術人員等，可從事各種工業生產、製造、生化製藥產業等工作

商業類

就業選擇

商業管理、物流管理、商業服務、會計師、金融分析師、國際翻譯人才、經貿等相關行業，或是自行創業（包含實體店面或網路店面）



家事類



就業選擇

觀光導遊、展場設計、服裝設計、幼兒園教學、社會工作、時尚造型、照顧服務、餐飲服務等相關行業



農業類

就業選擇

農牧場經營、園藝造景、植物病蟲害技術人才、獸醫、食品工業、生物技術、食品檢驗分析等相關行業



海事 水產 類



就業選擇

國際航海員、引水員、遊艇維修、商船輪機員、休閒漁業導覽、水產養殖相關行業



藝術與設計類



就業選擇

動畫設計、視覺藝術、舞台設計、圖文傳播、表演藝術、時尚工藝、舞蹈音樂等相關行業



技職教育有前途

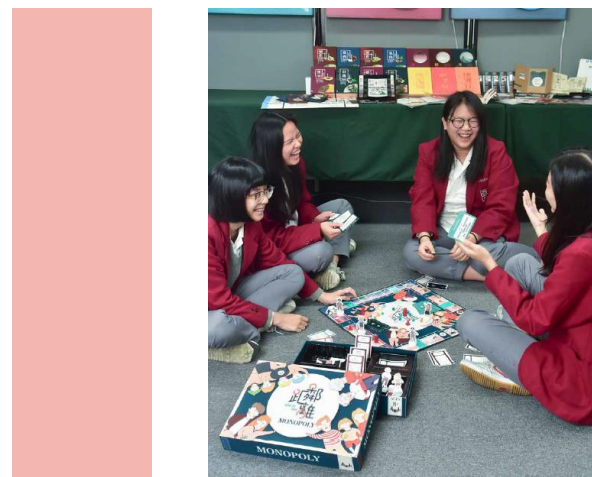

以培育具備專業、
實作技術能力、優
質專業人才為目標

3

選技職



我的未來不是夢

國中畢業生
升學進路圖

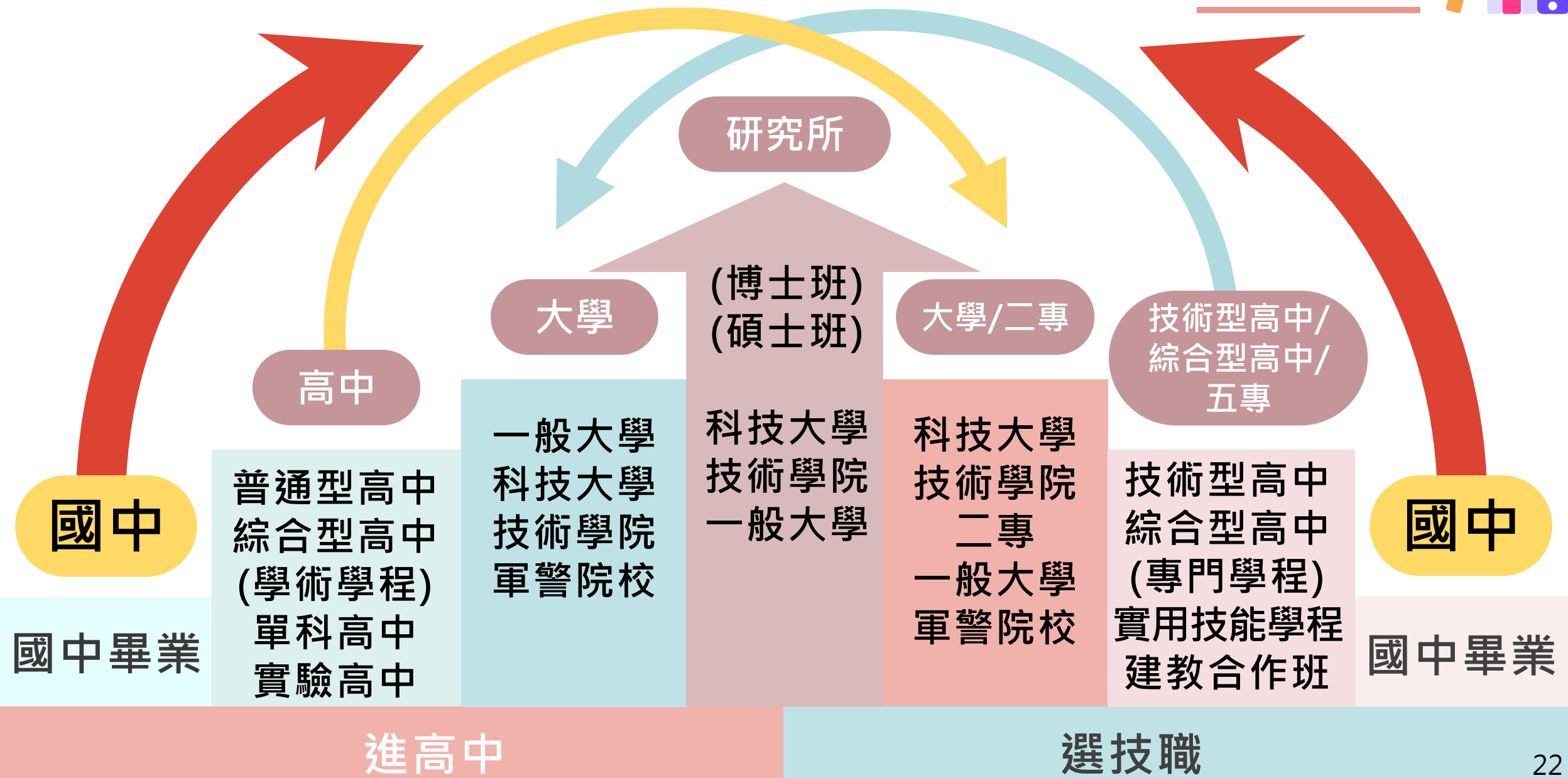

選技職 —築夢踏實



夢想啟航—從認識技職開始

技職大玩JOB 統一公告活動

技職大玩JOB 網站

1. **線上展覽**：360度視角精彩重現上一期展，延續展示效益。
2. **互動體驗遊戲**：輕鬆有趣互動小遊戲，將技職群科知識納入。
3. **梅克獅養成遊戲**：從養成過程中引導完成技職體驗任務。



合作PaGamO 任務書

題型設計有職業、技職群科知識和職業試探展，**限時激勵答題**，提升大眾對技職教育的認識。



技職直播與 採訪報導

1. 邀請**國家產學大師**，以有趣**互動的直播**，即時提問和回覆，幫助學子對於技職教育進一步了解。
2. 採訪**技職之光**和社會上多元職群達人，分享學習與工作經驗。





選技職

好好讀

有前途！